

KODA™

LED UMBRELLA LIGHT WITH SOLAR CHARGER

ITM. / ART. 1281849
Model: LM56705

CARE & USE INSTRUCTIONS

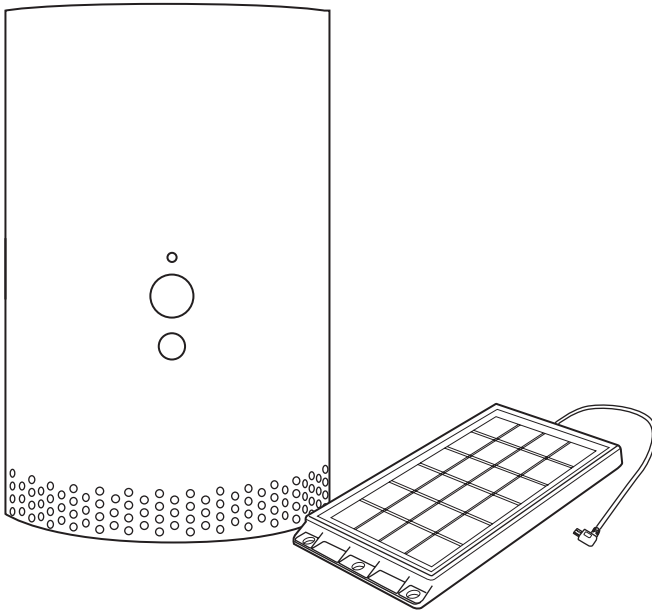

IMPORTANT, RETAIN FOR FUTURE REFERENCE: READ CAREFULLY

For questions or issues regarding the product, please contact Horizon Brands at 1-866-294-9244 (English) or send an email to info@kodabuilt.com. Representatives are available Monday through Friday from 8 AM to 5 PM (Pacific Time).

2975 Red Hill Ave., Ste. 100, Costa Mesa, CA 92626, USA

www.KodaBuilt.com

BC

SAFETY INSTRUCTIONS:

Read this manual thoroughly before first use and keep it in a safe place for future reference. To reduce injury to persons:

- Keep the LED Umbrella Light out of children's reach; it is not a toy.
- Protect the LED Umbrella Light from excessive heat.
- Do not submerge any parts of this product in liquid. This product is not waterproof.

WARNING:

- This product is not waterproof. Do not submerge in water or snow.
- LED light output is strong enough to injure human eyes. Precautions must be taken to prevent looking directly at the LEDs with diffuser removed for more than a few seconds.
- Do not tamper with or attempt to repair the LED component. The light source is designed for this specific application and should not be serviced by untrained personnel. Contact the customer service department if any servicing is required.
- The warnings, precautions, and instructions discussed in this manual cannot cover all possible conditions and situations that may occur. The operator must understand that common sense and caution are factors which cannot be built into this product, but must be supplied by the operator.

CLEANING:

- Clean the outside of the fixture with a soft, dry cloth or slightly dampened clean cloth. Never use a cleaner with chemicals, solvents, or harsh abrasives to clean the product.

PACKAGE CONTAINS:

Please layout all parts prior to installation. Read instructions prior to installation.

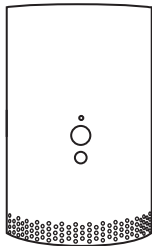

1 x LED Umbrella Light

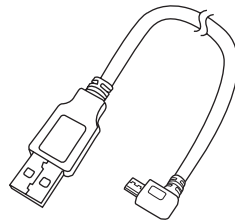

1 x Micro USB Charging Cable

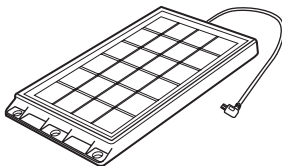

1 x Solar Charging Panel

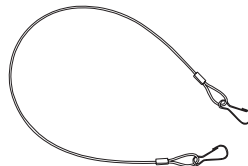

1 x Hanging Wire

TECHNICAL SPECIFICATION:

- Power Input: 5 V dc, 1A
- Light Output: 250 lm Upward Beam; 250 lm Downward Beam
- Battery Capacity: 4000 mAh
- Color Temperature: 4000K (Bright White)
- LED Life: 50,000 hrs *
- Operating temperature: 0°C - 40°C / 32°F - 104°F

Fits most market-style umbrellas from diameter 1.25 in - 2.25 in (31.7 - 57.1 mm)

* 50,000-hour lifespan is for the LED only. Lifespan depends on operating temperature, environmental conditions, etc.

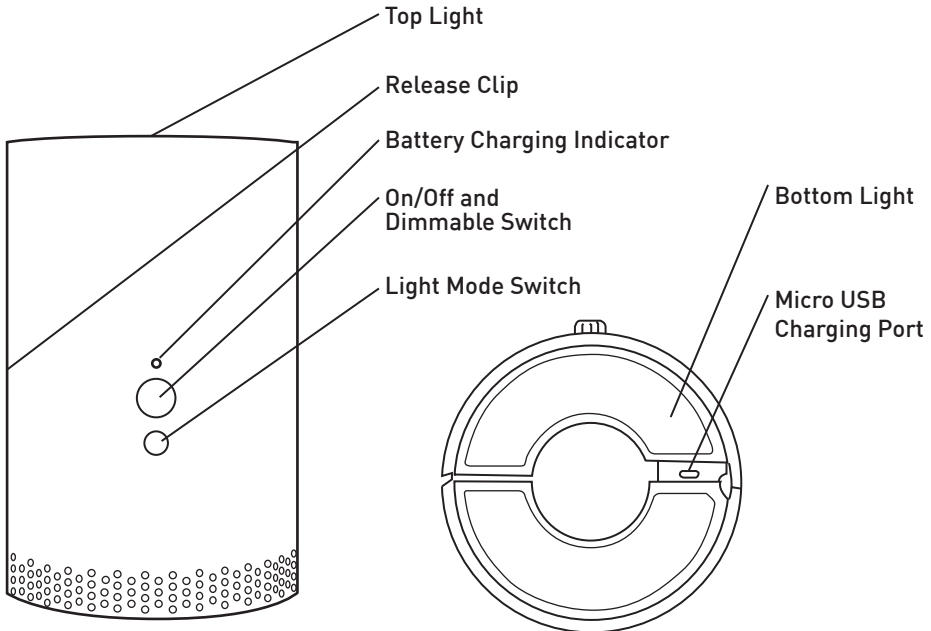
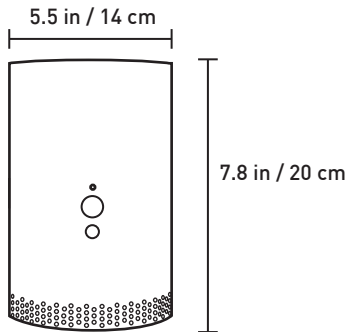

BEFORE FIRST USE:

You must charge the battery prior to first use, either by Solar Charging Panel, or with Micro USB Charging Cable.

Step 1: Open the Umbrella Light

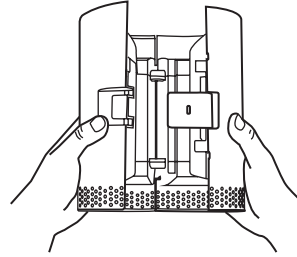
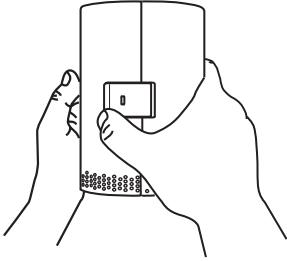

Step 2A: Connect to Solar Charging Panel. The Battery Charging Indicator will turn RED while charging.

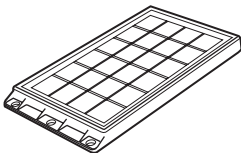
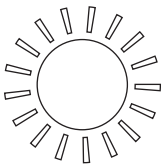
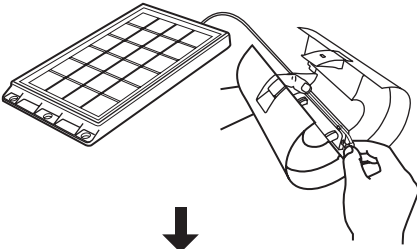

OR

Step 2B: Connect to Micro USB Charging Cable. The Battery Charging Indicator will turn RED while charging. (Adaptor is not provided.)

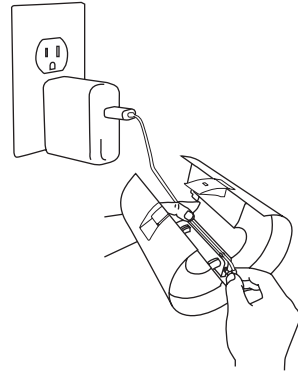

Step 3: Charging complete. The Battery Charging Indicator will turn green when the battery is full via Micro USB Charging Cable. Do not overcharge the battery. Remove the Micro USB Charging Cable when the indicator light turns green.

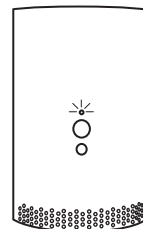

OPERATION:

The light can be used as either as Umbrella Light, or as tabletop light. It is suitable for indoor or outdoor use in covered locations. However, the light should not be exposed to heavy rain or be submerged in water.

Step 4: Open the Umbrella Light

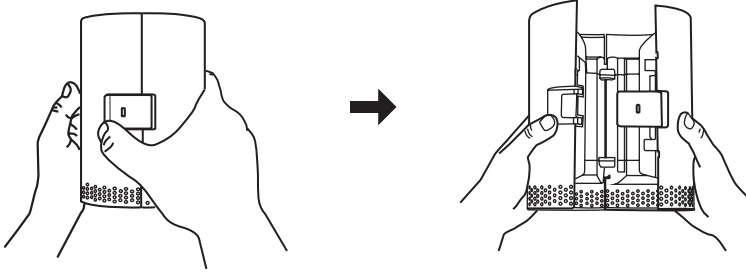

Step 5: Secure the Hanging Wire clasps to the Solar Charging Panel. Create a loop with Hanging Wire and tuck it under your umbrella cap.

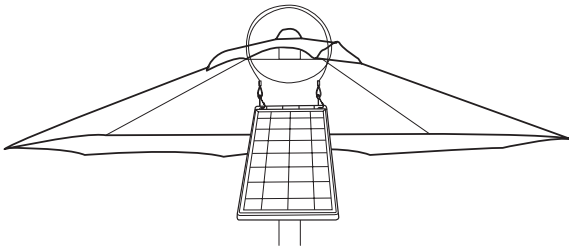

Step 6: Connect to Solar Charging Panel

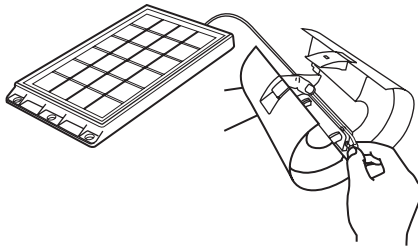

Step 7: Attach onto umbrella

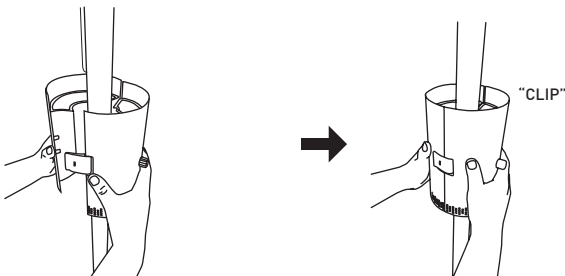

Step 8: Turn ON the light

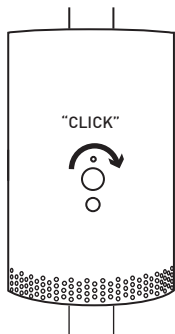

Step 9: Adjust brightness

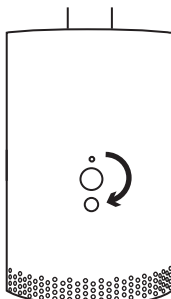

Brighter

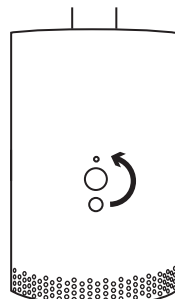

Dimmer

Step 10: Choose light mode

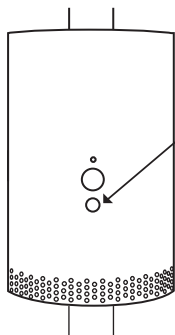

Press the Light Mode Switch to choose the light mode:

- Dual Beam: Both Top and Bottom Lights ON
- Upward Beam: Top Light ON
- Downward Beam: Bottom Light ON

For use as tabletop light, you can place the light on table, and repeat Steps 8-10.

TURN OFF:

Step 11: Turn OFF the light

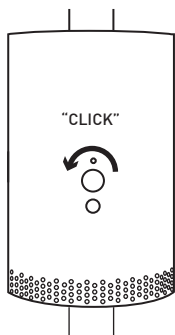

TROUBLESHOOTING:

ISSUE	CAUSE	REMEDY
The light is not working	The light is not switched ON	Turn on the light
	The battery has run out	Recharge the battery and then turn on the light again
	LED light or internal battery is at end-of-life	Dispose the product at your local recycling center
	The light is under sleep mode. When the battery has run up with the switch is ON, the light will be remained at OFF when the battery is charged up again.	When the battery is recharged, turn OFF the switch (with 'click' sound) and turn ON again, in order to reset from sleep mode. The light will be on again.
Only Top / Bottom Light Panel turns ON	The light is on a different light mode	Press Light Mode Switch to choose appropriate light mode

BATTERY DISPOSAL:

The battery is self-contained and not consumer replaceable. The battery must be disposed of properly when it no longer holds a charge. Proper charging practices will increase the life of the product. For information on battery recycling, call toll-free 800-822-8837.

Warning: Changes or modifications to this unit not expressly approved by the party responsible for compliance could void the user's authority to operate the equipment.

FCC / IC COMPLIANCE STATEMENT:

This device complies with Part 15 of the FCC rules and Industry Canada. Operation is subject to the following two conditions: (1) this device may not cause harmful interference, and (2) this device must accept any interference received, including interference that may cause undesired operation.

The manufacturer is not responsible for any radio or TV interference caused by unauthorized modifications or change to this equipment. Such modifications or change could void the user's authority to operate the equipment.

This equipment has been tested and found to comply with the limits for a Class B digital device, pursuant to part 15 of the FCC Rules. These limits are designed to provide reasonable protection against harmful interference in a residential installation. This equipment generates, uses and can radiate radio frequency energy and, if not installed and used in accordance with the instructions, may cause harmful interference to radio communications. However, there is no guarantee that interference will not occur in a particular installation. If this

equipment does cause harmful interference to radio or television reception, which can be determined by turning the equipment off and on, the user is encouraged to try to correct the interference by one or more of the following measures:

- Reorient or relocate the receiving antenna.
- Increase the separation between the equipment and receiver.
- Connect the equipment into an outlet on a circuit different from that to which the receiver is connected.
- Consult the dealer or an experienced radio/TV technician for help.

LED Umbrella Light

LM56705

Responsible Party:

Horizon Brands

2975 Red Hill Ave., Ste. 100, Costa Mesa, CA 92626, USA

Tel: 1-866-294-9244

CAN ICES-005 (B) / NMB-005 (B)

WARRANTY: HORIZON BRANDS LIMITED WARRANTY

This Horizon Brands product carries a 1 year warranty against defects in workmanship and materials. This product is not guaranteed against wear or breakage due to misuse and/ or abuse.

NOTE: Warranty only applies for North American customers of purchases made in North America.

Conditions of Warranty

If during the 1 year warranty period your new product is found to be defective, Horizon Brands will repair such defect, or replace the product, without charge for parts or labor subject to the following conditions:

- All repairs must be performed by Horizon Brands.
- All warranty claims must be accompanied by a copy of the sales receipt or bill of sale.
- The equipment must not have been altered or damaged through negligence, accident, improper operation, or failure to follow the product instructions for installation, use, or care.
- The replacement of parts is excluded from the warranty when replacement is necessary due to normal wear and tear.
- Repair or replacement parts supplied by Horizon Brands under this warranty are protected only for the unexpired portion of the original warranty.
- This is a “repair or replace” warranty only, and does not cover the costs incurred for the installation, removal or reinstallation of the product.

OWNER’S RESPONSIBILITIES: Horizon Brands will make every effort to provide warranty service within a reasonable period of time. **SHOULD YOU HAVE ANY QUESTIONS ABOUT SERVICE RECEIVED OR IF YOU WOULD LIKE ASSISTANCE IN OBTAINING SERVICE, PLEASE CALL TOLL FREE 1.866.294.9244 DURING REGULAR BUSINESS HOURS MONDAY THROUGH FRIDAY 9:00 AM TO 5:00PM (Pacific Time).**

NOTE: Toll Free # is for North America customers ONLY. See customer service section for customer contact numbers for other regions/offices. For customer service and technical support, please call us at 1.866.294.9244 or email us at info@kodabuilt.com. If at that time it is determined that a replacement unit is needed, the support representative will issue a Return Authorization and instruct on how to get a new unit. Horizon Brands makes no other warranty of any kind aside from the limited express warranty stated herein.

DISCLAIMER OF WARRANTIES, INCLUDING WARRANTY OF MERCHANTABILITY AND WARRANTY OF FITNESS FOR PARTICULAR PURPOSE: EXCEPT AS SPECIFICALLY SET FORTH HEREIN, NO WARRANTY OR REPRESENTATION, EXPRESS OR IMPLIED, IS MADE AS TO THE LED UMBRELLA LIGHT. HORIZON BRANDS AND/OR ITS AFFILIATES EXPRESSLY DISCLAIMS, WITHOUT LIMITATION, ANY STATUTORY WARRANTIES AND ALL IMPLIED WARRANTIES, INCLUDING ANY IMPLIED WARRANTY OF MERCHANTABILITY OR FITNESS FOR A PARTICULAR PURPOSE.

**DISTRIBUTED BY:
Costco Wholesale Corporation
P.O. Box 34535
Seattle, WA 98124-1535, USA
TEL: 1-800-774-2678
www.costco.com**

Made in China

 Have a comment or question? Email us at info@kodabuilt.com
or visit us online at www.KodaBuilt.com

H O R I Z O N
B R A N D S

2975 Red Hill Ave., Ste. 100, Costa Mesa, CA 92626, USA | Tel: 1-866-294-9244
© 2018 Horizon Brands. All rights reserved.